

NOTES:

- ① HIGH PRESSURE LAMINATED BLACK PLASTIC SHELF (STAINLESS STEEL OPTIONAL)
- ② 12 GA. STAINLESS STEEL FRAME
- ③ 16 GA. STAINLESS STEEL DIP TRAY
- ④ NATURAL VOICE SPACERS
- ⑤ ARMORTEX® BULLET RESISTANT GLAZING
- ⑥ 20 GA. STAINLESS STEEL CAP TOP AND BOTTOM OF GLAZING
- ⑦ 25T DIA. ANCHOR HOLES (8-PLCS.) (ANCHOR AS REQUIRED, BY OTHERS)
- ⑧ REQUIRED FINISHED OPENING IS 1/4" GREATER THAN OVERALL DIMENSIONS
- ⑨ 16 GA. STAINLESS STEEL ANCHOR PLATE

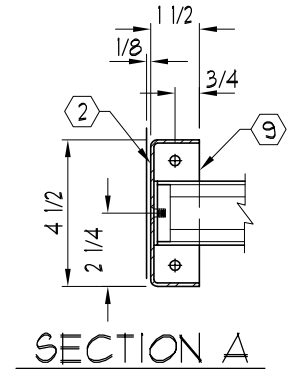

④ LISTED NATURAL VOICE FRAME

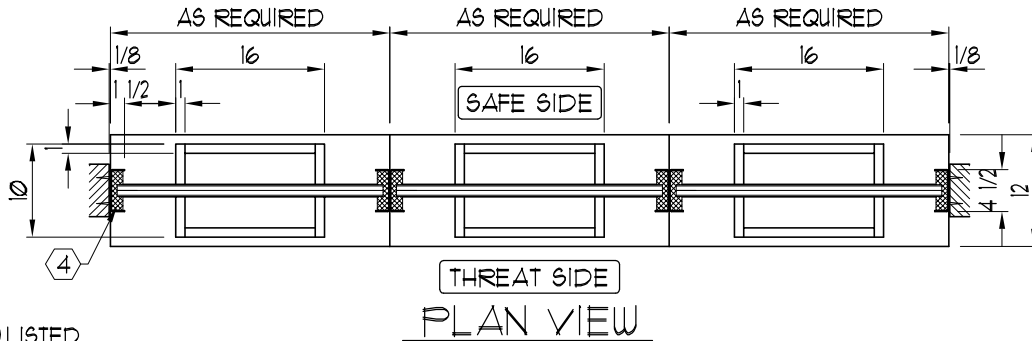
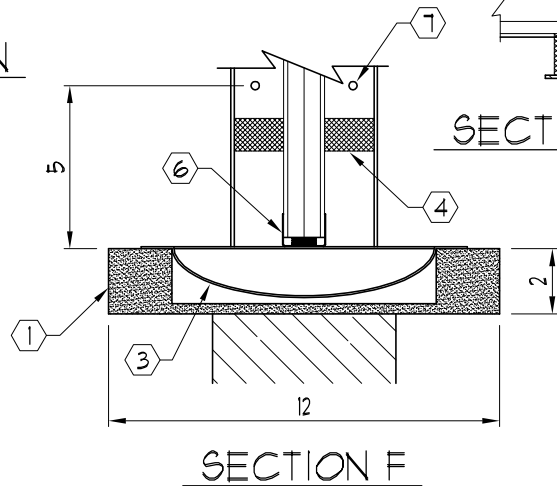
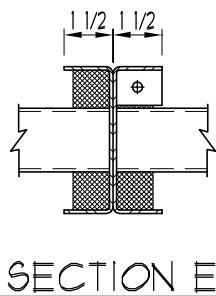
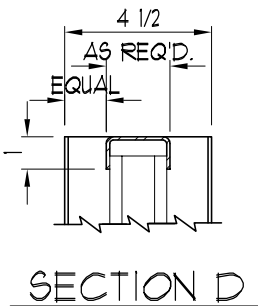
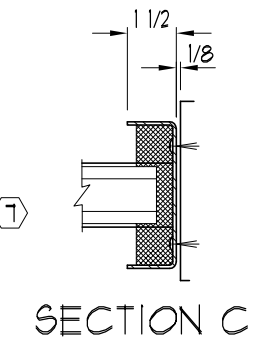
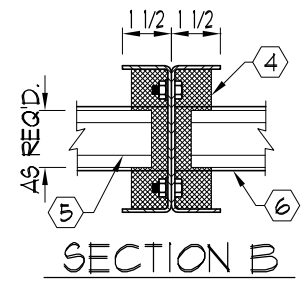
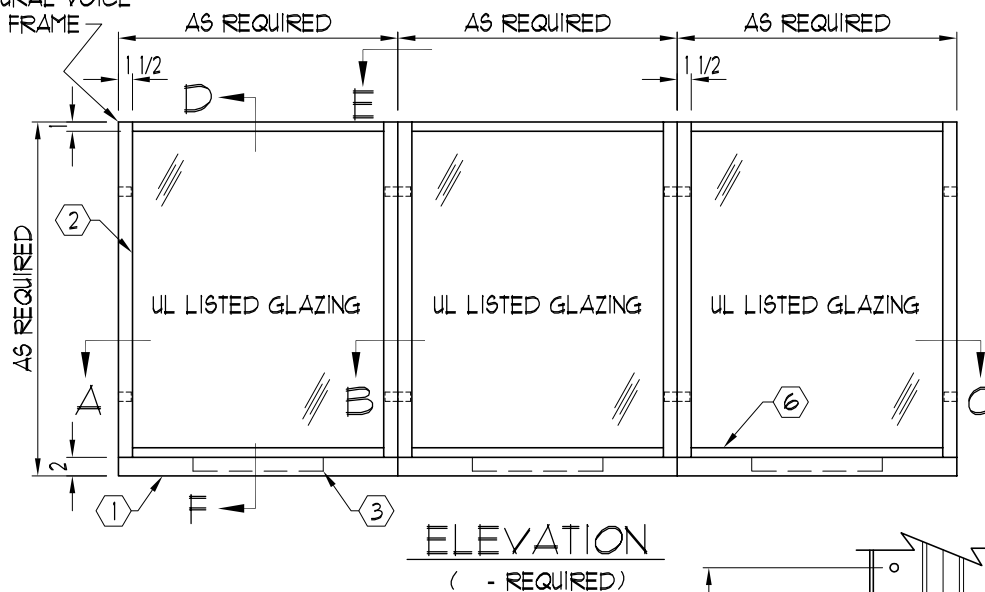

C:\ARMORTEX MASTERS - 2007\WINDOWS\W1011009.DWG.DWG 02/13/07 @ 09:25 User: aperez

REVISIONS			ARMORTEX® BULLET / BLAST RESISTANT PRODUCTS		BALLISTIC LEVEL	
No.	DESCRIPTION	DATE	5926 CORRIDOR PKWY SCHERTZ, TX 78154		DRN.BY:	DATE:
			TEL: 210-661-8306 800-880-8306 FAX: 210-661-8308		A. Perez	02-16-07
			TITLE: ARMORTEX® BULLET RESISTANT MULTIPLE TRANSACTION WINDOWS		CHKD.BY:	DATE:
			UNLESS OTHERWISE SPECIFIED ALL DIMENSIONS ARE IN INCHES		DRAWING No.	SHEET
			SCALE: NONE	PROJECT No.	W1011009	1 OF 1